

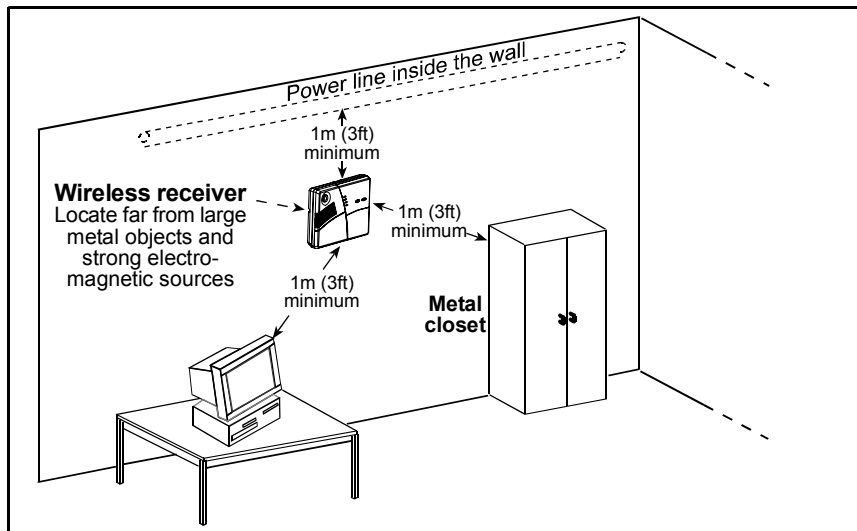

Receivers / Control Panels

1. Avoid Interference

Make sure that the area around the wireless receiver is free of any large metal objects (metal doors, metal closets) bigger than 50 cm (20 in.), or strong Electro-Magnetic sources (power conductors, P.C., cordless phone, light dimmer, etc.). A distance of at least 1 meter (3 ft) is recommended.



2. Choose the Right Location

The preferred location for the wireless receiver / control unit is in the center of the installation site. This helps to achieve maximum reception signal from all transmitters in the installation site.

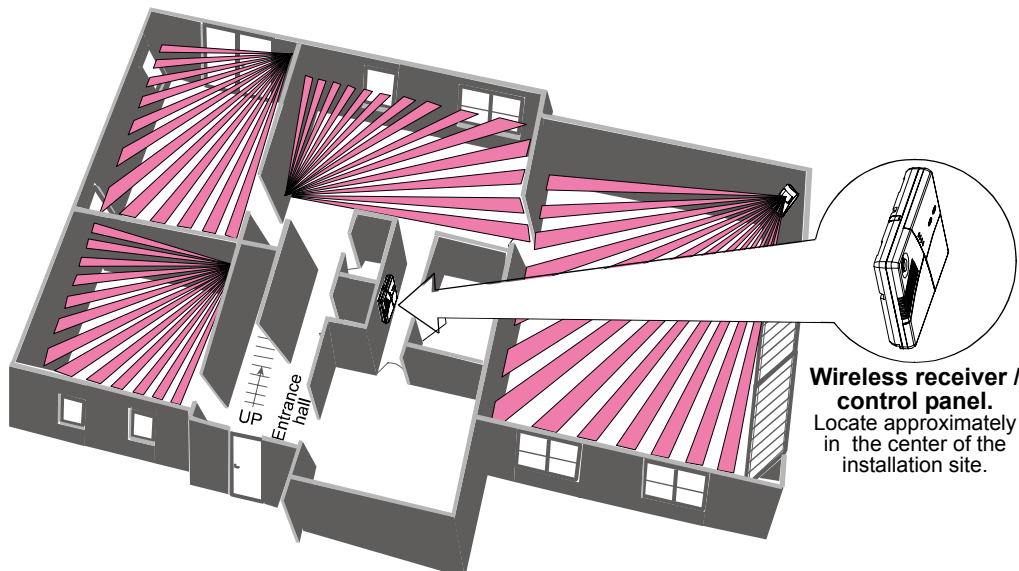

Transmitters

3. Avoid Interference

Make sure that the area around the wireless transmitter is free of any large metal objects (metal closets, metal doors) bigger than 50 cm (20 in.).

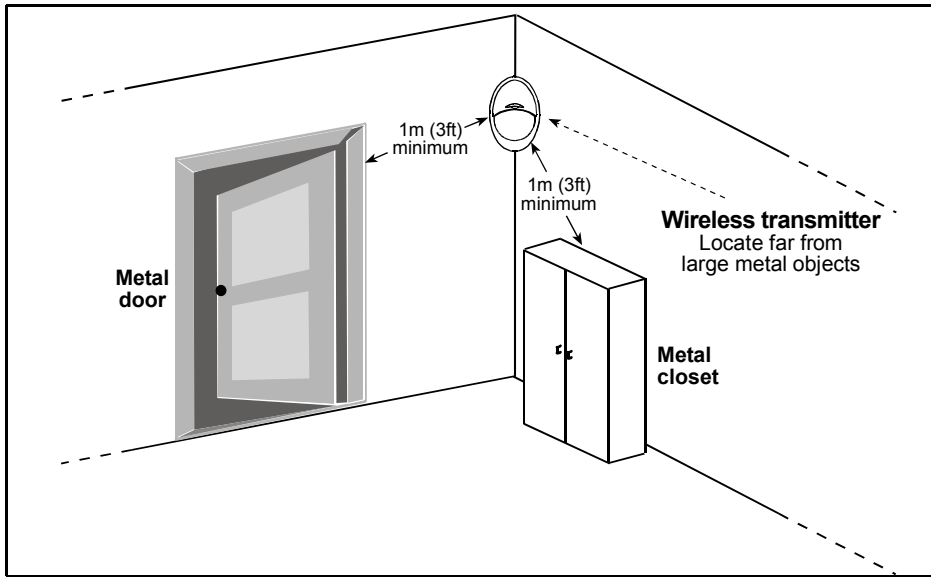

4. Assure Good Signal Reception

Make sure that the signal reception level, shown in the Diagnostics tool of the PowerMax for each transmitter's signal, is "**Strong**" or "**Good**".

Do not accept "poor" reception level. In this case, attempt to relocate the wireless transmitter/detector to a new location and then check again. Even a slight change of the transmitter or the receiver location can make a big difference. If this doesn't help, a wireless repeater may be needed.

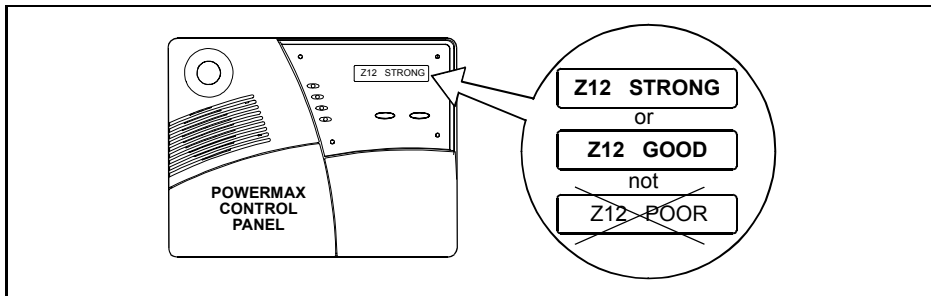

5. Magnetic Contacts - Assure Correct Installation

- Wireless Magnetic contacts should be installed in a vertical position and as high as possible.
- Attach the transmitter to the top of the door or window fixed frame.
- Attach the magnet to the moveable part of the door or window, at a maximum distance of 6 mm (0.25 in.) from the transmitter.

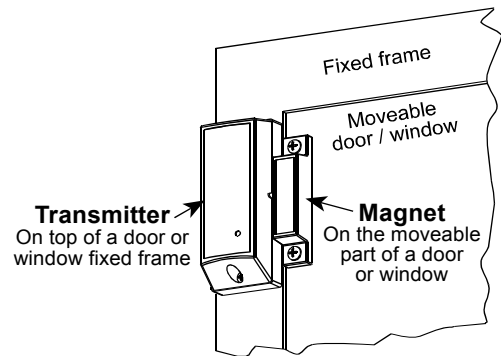

6. PIR Detectors - Assure Correct Location

Wireless PIR detectors should be installed at the height specified in their installation instructions.

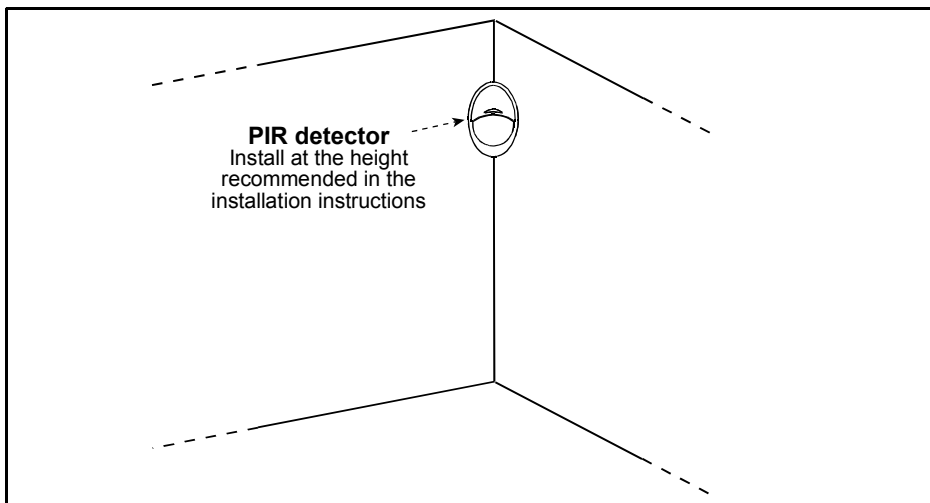

Wireless Repeaters

7. Choose the Right Location

- Repeaters should be located high on the wall and the antenna must be in a vertical position outside of the plastic box.
- The location should be approximately in the middle between the receiver and the transmitter whose range needs to be extended.

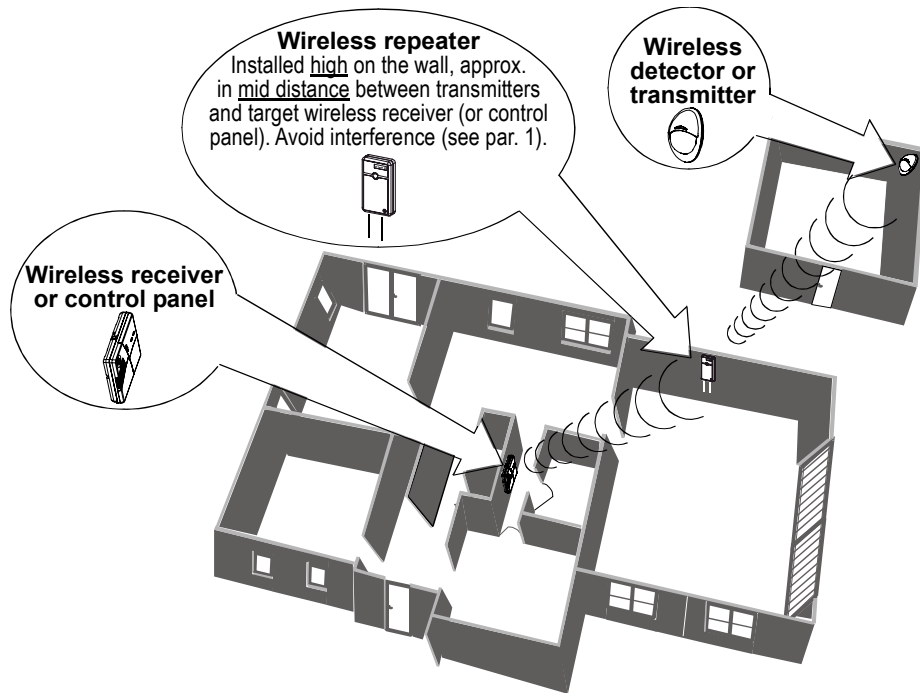

Using Wireless Repeater



Visonic

VISONIC LTD. (ISRAEL): P.O.B 22020 TEL-AVIV 61220 ISRAEL. PHONE: (972-3) 645-6789, FAX: (972-3) 645-6788
VISONIC INC. (U.S.A.): 10 NORTHWOOD DRIVE, BLOOMFIELD CT. 06002-1911. PHONE: (860) 243-0833, (800) 223-0020. FAX: (860) 242-8094
VISONIC LTD. (UK): FRASER ROAD, PRIORY BUSINESS PARK, BEDFORD MK44 3WH. PHONE: (0870) 730-0800 FAX: (0870) 730-0801
INTERNET: www.visonic.com
©VISONIC LTD. 2003 Installing Wireless Systems DE2000W (REV. 0, 9/03)